

MODEL: GT-BS03D

Oder Code	GT-BS03D
LED	5W/Pcs
Row	Single Row
Operating Voltage	10-30V DC
Operating Temp	-40~+60 °Celcius
Beam Pattern	Flood, Spot, Combo
ColorTemperature	6000K
Lifetime	30000+h
Lens Material	Polycarbonate
Housing Material	Aluminum
Coating Powder	Sand Black
Mounting System	304 Stainless Steel SideMount Aluminum Bottom Mount
Pressure Equalization Vent	Yes
Waterproof Rate	IP67
EMC Protection	ECE R10, CISPR 25 Class 3

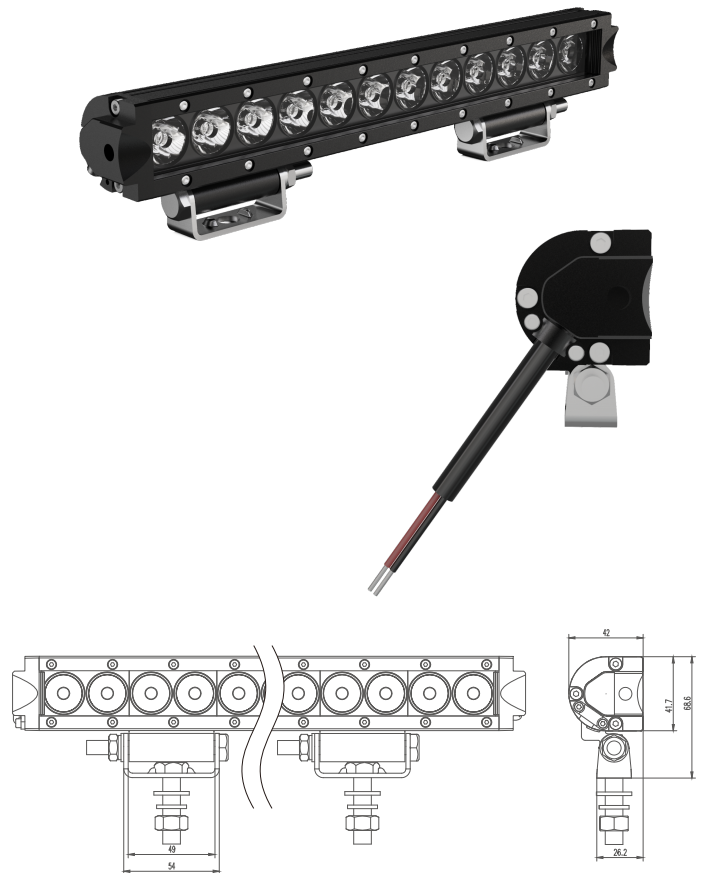

MODEL	Size	Watt	AMP Draw	Leds	Theoretical Lumen	Cable Length	Net Weight	Package Standard
GT-BS03D-6L	7.20"	30W	1.50A@12V, 0.75A@24V	6PCS*5W	3000Lm	400mm	0.50Kg/Pcs	10Pcs/Carton
GT-BS03D-12L	13.00"	60W	3.00A@12V, 1.50A@24V	12PCS*5W	6000Lm	400mm	0.90Kg/Pcs	10Pcs/Carton
GT-BS03D-20L	20.80"	100W	5.00A@12V, 2.50A@24V	20PCS*5W	10000Lm	400mm	1.50Kg/Pcs	10Pcs/Carton
GT-BS03D-30L	30.60"	150W	7.50A@12V, 3.75A@24V	30PCS*5W	15000Lm	600mm	2.20Kg/Pcs	6Pcs/Carton

